

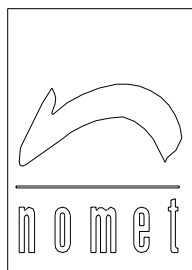

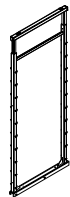

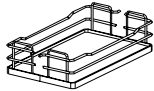

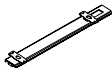
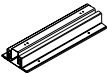
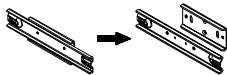
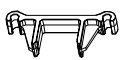

Cargo Baskets MAXI and MIDI / Kosze Cargo MAXI i MIDI
PRESTIGE SUPREME

07-10-2015 v.1



Pos/Poz	DRW/RYS	MODEL	Part name / nazwa czesci	W-5000D	W-5500D	W-5600D
				W-5400D	Qty/Ilosc	Qty/Ilosc
1		Frame / Rama		1		
2		Basket / Kosz		4	5	6
3		Upper slide / Prowadnica gorna		1		
4		Lower slide with cover Prowadnica dolna z oslonami		1		
5		Mounting front / Mocowanie frontu		3	4	4
6		Handle basket / Uchwyt kosza		8	10	12
7		Screw M6 L = 10mm - head with spherical Wkret M6 L=10mm z lbem z kulistym		10		
8		Button head $\varnothing 4,2$ L=16mm self-tapping screw Wkret $\varnothing 4,2$ L=16mm z lbem z podkladka		4		
9		Button head $\varnothing 4,2$ L=19mm self-tapping screw Wkret $\varnothing 4,2$ L=19mm z lbem z podkladka		18		
10		Flat head screw M6 L=10mm Wkret M6 L=10mm z lbem stożkowym		2		
11		Flat head screw M5 L=10mm Wkret M5 L=10mm z lbem stożkowym		8		
12		Hex socket set screw with flat point M6 L=6mm Wkret dociskowy imbusowy M6 L=6mm - plaski		8		
13		Hex socket set screw with cone point M6 L=16mm Wkret dociskowy imbusowy M6 L=16mm - stożek		2		
14		Allen key 3mm / Klucz imbusowy 3mm		1		

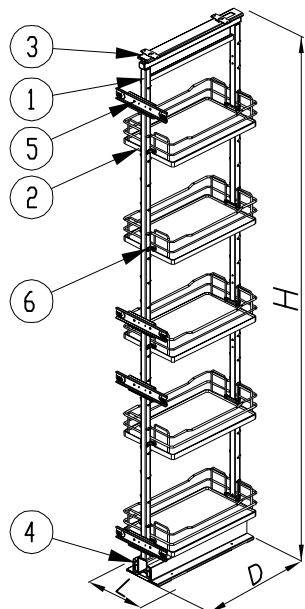

	Model				D	L
	Cargo MIDI	Cargo MAXI				
W-5000D-300	W-5400D-300	W-5500D-300	W-5600D-300	500	250	
W-5000D-400	W-5400D-400	W-5500D-400	W-5600D-400	500	350	
W-5000D-500	W-5400D-500	W-5500D-500	W-5600D-500	500	450	
W-5000D-600	W-5400D-600	W-5500D-600	W-5600D-600	500	550	
H min	1210	1410	1710	1910		
H max	1410	1710	1910	2110		

REMARKS / UWAGI:

Max capacity / maksymalne dociazenie systemu - 120kg